

# LINNENBERG

Owner's Manual

TELEMANN

## Introduction



TELEMANN realizes a high performance audio source without drawbacks. The playback of audio files at CD quality (1411 kbps) is absolutely comparable, if not better than the reproduction of a pure high class CD-player. The result you get from the TELEMANN depends strongly on the resolution of the audio file you play and on the correct settings of your computer or streamer running the audio software.

In contrast to a red book CD-player, a computer in conjunction with TELEMANN's USB input can play files with extremely high resolution and with different formats like WAV, FLAC or DFF (DSD bitstream). Such music files can be downloaded on specialist internet shops like 2L.no, HDtracks.com or highresaudio.com to name but a few. The choice of music and the number of albums available is clearly limited today, but new releases show up every day. The big advantage here is that you are not bound to a certain format like SACD or DVD-Audio. Computer audio is future proof.

The second essential digital audio format is S/PDIF (Coax 1, 2, AES/EBU and optical). The TELEMANN supports sample rates up to 192kHz and bit depths up to 24bit.

Furthermore, you can optionally use the cinch output pair as analog input by altering two internal jumpers. By abandoning the unsymmetrical output, you now get a full working preamplifier for use with a phono stage for instance.

Controls – front

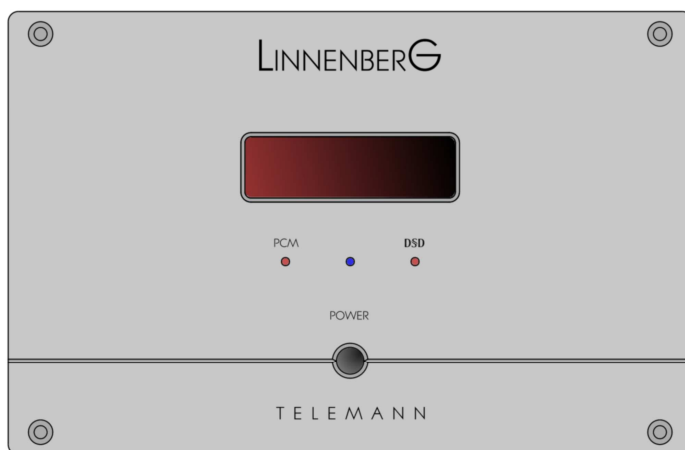

(Figure 1)

Connections - rear

Default: cinch  
output pair;  
optionally  
useable as  
analog input !

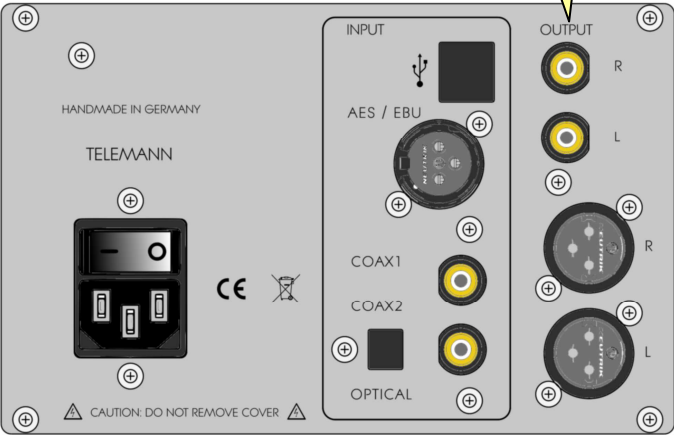

(Figure 2)

## Basic operation

Room temperatures over 30 degrees Celsius and / or extreme humidity should be avoided. Keep away from heat sources like radiators, heating, ovens or similar appliances dissipating heat. It is important to maintain an adequate supply of airflow to prevent overheating.

Place the unit on a solid, flat level surface such as a shelf where it is convenient to operate.

Before connecting the TELEMANN to your mains the first time, check if the indicated mains voltage is in accordance with your home supply. Never plug an 115V version in a 230V mains socket or serious damage will occur.

There is no need to operate the mains ON / OFF switch on the back side of the TELEMANN since the standby power consumption is less than 0,5W. As it is common practice, disconnect TELEMANN from the mains during a thunderstorm or when going on vacation.

Once the power cord is connected, the blue LED should light up when the power switch and subsequently the front panel push button are operated. The red display shows "TELEMANN" in form of a ticker. Turn off the unit by pushing the front button again and do the signal connections according to figure 2. If everything is connected, turn on and have fun!

### Remote control operation



To enhance the versatility of the TELEMANN as an analog / digital preamp, all functions are remote controllable. The unit responds to the remote provided with the unit. Should you experience the fail of an action subsequent to a button pressing, please press the button again. Flat batteries, too long distance / angle or an obstructed light path may be the reason.







(Figure 3)

Besides controlling the volume, the remote enables the user to mute the output, select the input source and choose the digital filter mode for PCM input sources.



Mute	
<p>Pressing the &lt;Mute&gt; button on the remote mutes the output. Releasing the mute action is either by pressing &lt;Mute&gt; again or by pressing the volume buttons. Please note: the mute function is not available for the analog source.</p>	
Select	
<p>Pressing the &lt;Select&gt; button subsequently changes the input source of the TELEMANN. Inputs USB, AES (symmetric digital input), Coax1, Coax2, optical (Toslink) and the analog input option are selectable.</p>	
	

Select (cont.)	
<p>The output cinch pair on the rear of TELEMANN can be used as an unsymmetrical analog input when the relevant jumpers inside the TELEMANN have been changed from outputs (default factory setting) to inputs. Please note: the mute function is not available for the analog source.</p>	
Mute + Select	
<p>Pressing &lt;Mute&gt; first to enter the mute mode and thereafter &lt;Select&gt; lets you change the filter setting of digital filter. 7 options are available through DF1 to DF7</p>	

Volume -, Volume +	
<p>The volume control works simultaneously for both analog outputs, as long as the cinch pair is used as output. The control range spans from -70 ... +6dB in increments of 1.2dB. If you wish to drive a preamplifier or an integrated amplifier, you may turn the volume to full scale = 63. Minimum is = 0.</p>	
	

### Display

The red 14 segment display operates in noise free DC-modus. No multiplex action resulting in degrading the sound quality of the TELEMANN takes place. Nevertheless, some users prefer to have a dimmed listening ambience where the light from the display could perturb the tranquillity. When first powering up the TELEMANN, the display will be on for 20s before going in to sleep mode. Pressing any of the remote control buttons lights up the display for at least 10s, before going dark again. The status LED indicators for PCM, DSD and power on are always operating.

## Digital Filter selection

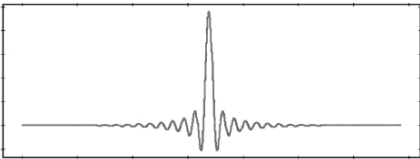
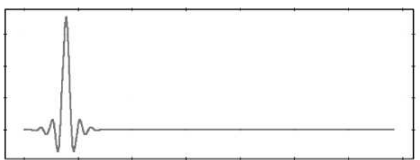
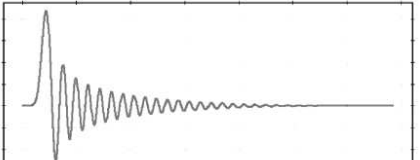
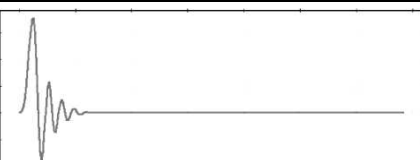
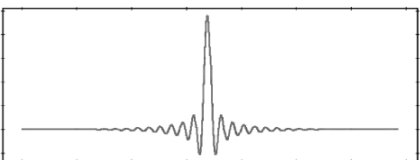
DF1	
Fast roll off, linear phase. Standard PCM filter with highest stop band rejection.	
DF2	
Slow roll off, linear phase.	
DF3	
Fast roll off, minimum phase.	
DF4	
Slow roll off, minimum phase.	
DF5	
Apodizing, fast roll off, linear phase.	

## Digital Filter selection (cont.)

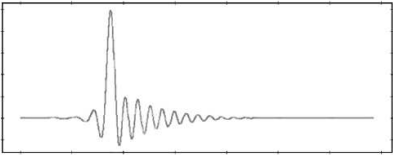
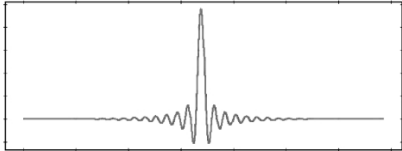
DF6	
Hybrid, fast roll off minimum phase.	 A waveform plot showing a sharp initial peak followed by a series of smaller, decaying oscillations, characteristic of a minimum phase filter.
DF7	
Brick wall filter	 A waveform plot showing a sharp initial peak followed by a series of smaller, decaying oscillations, characteristic of a brick wall filter.

## Pushbutton operation

As stated earlier in this document, there is no need to operate the hard wired mains switch on the rear of the TELEMANN. If you want to switch on or off the unit, use the front panel pushbutton. Doing so, TELEMANN stores the current settings (volume, input, filter) even when the mains voltage is lost thereafter.

## Jumper setting

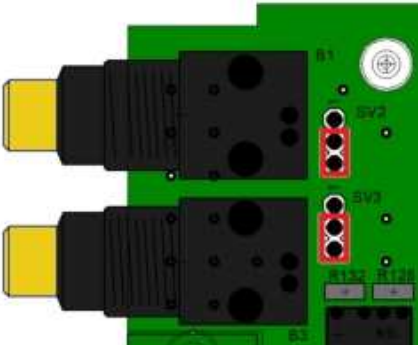
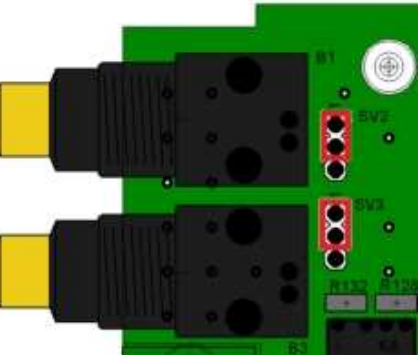
<p>Cinch pair is unsymmetrical output. Do not connect any source.</p> <p>Factory default setting.</p>	
<p>Cinch pair is analog input (ANA)</p>	

(Figure 4)

## Driver installation

### Installing process (Mac)

No drivers are required for the Mac computer with OSX 10.6.4 and later. A native support for audio devices compliant with USB 2.0 Audio class is already included in the operating system. Your TELEMANN will be immediately recognized by the OS and ready to use. Be sure to select the TELEMANN (Combo384 Amanero) as output device in the "System Preferences / (Hardware) Sound / Output" menu. In the "Applications / Utilities / Audio Midi setup.app" menu you can select the standard sample rate which is (44100 Hz) for CD sourced music. Using high end audio player software instead of iTunes is recommended.

### Installation process (PC)

Do not connect the TELEMANN to your computer yet, first download and install the driver. !

The newest version of the installation package for TELEMANN *performance pack edition* offers a single executable for all Windows operating systems and native ASIO driver for 32 and 64bit systems. Double click on the file in order to install the complete package. Restart your PC or

Notebook and connect the TELEMANN to the host for the first time. The TELEMANN will now be recognized as usable device.

When the driver installation is done, you are ready to play music via USB. As long as the TELEMANN is connected, it is automatically selected as output device. As it is the case with Mac computer, we highly recommend using special software instead of the Windows Media Player.

## JPLAY (PC)

There are numerous high performance audio players for Mac and Windows OS available. Describing all of them would definitely go beyond the scope of this manual. If you should encounter problems with specific software, please feel free to send an enquiry regarding the matter. We will be happy in assisting you rectifying the subject.

Representative for a high quality audio player the JPLAY software is presented. The reason why JPLAY was chosen is simple: it sounds awesome and is easy to use – even for computer newbie's. The actual version is ready for DSD playback. Please feel free to order your software licence at [www.jplay.eu](http://www.jplay.eu) . The only drawback is the very basic to non existent user interface. Those of you not willing to except the limited functionality can use JPLAY as ASIO output device in foobar2000 or just work with



foobar2000 alone. Foobar2000 is free of charge, but needs to be adapted for DSD playback capability. Here is what to do:

Foobar2000 (PC for PCM and DSD playback):

Install the latest version of foobar2000 from the official website [www.foobar2000.org](http://www.foobar2000.org) . Download the kernel streaming support from the components section of the website. This allows you to have a bit-perfect transfer via USB. Decompress the file and copy the file "foo\_out\_ks.dll" in the directory "components" of the foobar2000 directory.

After having successfully installed all foobar2000 components, connect the TELEMANN to your PC. Now start the foobar2000 player. Click on "file"; a drop down menu will appear; here go to "preferences". Select "playback / output". Now you have to make several adjustments:

Device :	KS: Amanero Technologies Streaming
Buffer length :	1000ms
Output format :	32bit

That's the default setting for PCM files like WAV, FLAC or even MP3. In order to use the DSD

capability of the TELEMANN, you have to do the following: First, you need to download and install the Super Audio CD Decoder plug - in at:

*[www.sourceforge.net/projects/sacddecoder/files/foe\\_input\\_sacd/](http://www.sourceforge.net/projects/sacddecoder/files/foe_input_sacd/)*

Download "foe\_input\_sacd - 0.7.4.zip" (or later), open and extract all files. Then click and install "ASIOProxyInstall - 0.7.1.2.exe". After the installation is finished, copy the "foe\_input\_sacd.dll" file into the foobar2000 components folder. Next download and install the ASIO support 2.1.2 (or later version) plug - in:

*[www.foobar2000.org/components/view/foe\\_out\\_asio/](http://www.foobar2000.org/components/view/foe_out_asio/)*

Run the downloaded file foe\_out\_asio.fb2k - component to install the ASIO plug - in. Start foobar2000, click menu and select "file", and then enter the "preference" section. Jump to "playback / output" tab. Select "ASIO: foe\_dsd\_asio" as output device in the "Device" section.

Now it is time to install the appropriate ASIO (32 or 64bit) driver from the TELEMANN driver zip-file. Sometimes the installation is already carried out during the installation of the main driver executable. You won't have to do it again then.

In foobar2000 “preferences / playback / output / ASIO” you will see “foo\_dsd\_asio” as an ASIO driver option. Now configure “foo\_dsd\_asio” by double clicking on that entry. The following options will show up:

ASIO driver :	ASIO Combo 384 driver	
DSD Playback Method :	DoP Marker 0x05/0xFA  or ASIO Native	
DSD to DSD Method :	none	FS: DSD64
PCM to DSD Method :	none	FS: DSD64
DSD/PCM Transition :	50 ms	

Playing DSD256 or DSD512 files requires the selection of the native ASIO driver. 

Close the “foo\_dsd\_asio” pop-up window; go back to the “Tools / SACD” tab. Here, please select:

ASIO Driver Mode :	DSD
PCM-Volume :	+0dB
PCM Samplerate :	176000
DSD to PCM Mode :	Multistage
Preferable Area :	Stereo

Click "OK" button on Preferences windows and restart the program. You are now ready to play back PCM and DSD files with foobar2000.

### JRIVER (PC)

A combination of fine sound quality and ease of use is JRIVER. In contrast to foobar2000 there are just a few adjustments to do.

Output mode :	Kernel streaming
Bitstreaming / custom ...	Yes (DSD over PCM (DoP)) Format : DoP 1.0 (0xFA / 0x05)

The features of JRIVER are countless and thus can't be described here. However the above settings are essential for the sound quality we strive for. Our own experience showed that JRIVER delivers a flawless approach to a high class software player without the hassle of foobar2000 and without the limitations of JPLAY. As is the case with foobar2000, no audible switching noise between different formats occurs what so ever.

## AUDIRVANA PLUS (MAC)

A very user friendly and exceptional sounding software is Audirvana Plus. Just download the AudirvanaPlus\_1.5.12.dmg file and run it on your computer. Most of the settings are by default – there is very little to configure. Please select in Audirvana preferences menu:

Preferred Audio Device :	Combo384 Amanero
Native DSD capability :	DSD over PCM standard 1.0

You can even arrange Audirvana to upsample your PCM files in a case selective manner. Even if the iZotope plug in is one of the best software upsampler, we recommend playing your files in the native form as this guarantees the best over all performance. Upsampling is not making your source files any better; it just makes the transmission to the DAC more susceptible to jitter.

## TELEMANN mains voltage selection / fuse replacement

The following work should only be carried out by a qualified technician in accordance to highest electrical safety standards. Risk of electric shock. !

### Replacing the fuse

The fuse must be replaced by a 0.63AT type (5x20mm). Never attempt to short the fuse holder. Normally the fuse should never blow – if it has, it is a sign of a serious fault condition. Further investigation is needed.

### Mains voltage

Altering the mains input voltage range from 115V to 230V or vice versa is done by changing the fuses according to the figure 5 below. You will need 1x 0,63AT (= F1) for 230 V operation and 2x 0,63AT (= F2 and = F3) for 115V operation. Never attempt to apply any other fuse configuration or a short circuit condition will occur.

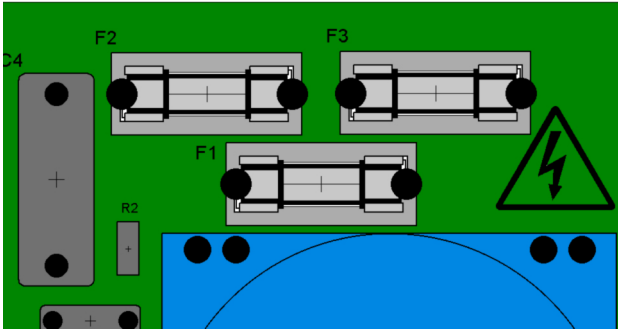

(Figure 5)

### Battery change

The remote control supplied with the TELEMANN is equipped with a Lithium battery CR2032. Battery life is usually more than a year, probably much longer. For replacing the battery one needs to dismantle the assembly. 4x bolts on the outside and 6x bolts in the inside have to be unscrewed before the remote PCB is accessible. The actual battery is fixed in a holder.

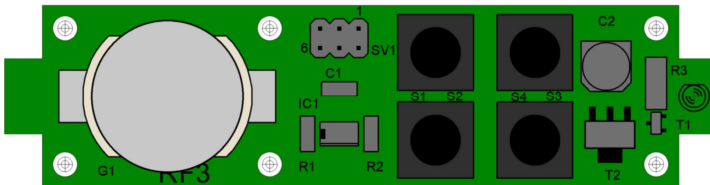

(Figure 6)

## Specifications

Sampling frequencies PCM :	44.1, 48, 88.2, 96, 176.4, 192, 352.8 kHz ; S/PDIF – input limited to 192 kHz max.
Resolution PCM :	32bit
Resolution DSD :	DSD64 (2.8224MHz) and DSD128 (5.6448MHz) over DoP protocol, DSD256 and DSD512 over ASIO native
Master clock jitter :	82 fs (femto seconds)
Frequency response :	DC - 24kHz +0.1dB - 0.5dB DC – 70kHz -3dB @192kHz
Distortion and noise :	<0.0003% 10Hz - 20kHz @ 0dB
Dynamic range :	138dB
Crosstalk :	120dB @ 20kHz
Output level :	4V rms single ended 8V rms balanced
Output impedance :	300 Ohm per phase
Power consumption :	8W, < 0.5W turned off
Dimensions (H x W x D) :	120 x 170 x 260 mm



## CE declaration of conformity

Product Type: Digital – Analog – Converter

Model: TELEMANN

Linnenberg-Elektronik declares that this product complies with the Low Voltage Directive 2014/35/EU and the Electromagnetic Compatibility Directive 2014/30/EU as well as the Ecodesign Directive 2009/125/EC.

The unit meets all currently valid regulations only in its original condition. The original, unaltered factory serial number must be present on the outside of the unit and must be clearly legible! The serial number is an essential part of our conformity declaration and therefore of the approval for operation of the ALLEGRO. The serial numbers on the unit and in manual, must not be removed or modified, and must correspond.

Furthermore, the unit has been found to comply with the limits for a Class B digital device, pursuant to Part 15, subpart B (unintentional radiators) of the FCC rules.

LINNENBERG – ELEKTRONIK

Germany

Phone: +49/178/7672984

Mail: info @ linnenberg-audio.de

© Linnenberg Elektronik 2017